

Features

- 30-inch minimum base cabinet width.
- Single bowl.
- 9-inch depth.
- Short 6-11/16-inch apron allows sink to be used in new or existing standard cabinetry.
- Self-Trimming apron overlaps the cabinet face for easy installation.
- No faucet holes.
- Basin slopes 2 degrees toward drain to minimize water pooling.
- Offset drain increases workspace in the sink and storage space underneath.
- Includes cutout templates.

Material

- KOHLER® enameled cast iron.

Installation

- Under-mount apron-front.

Recommended Products/Accessories

K-9000 P-Trap
K-6638 Sink Rack
K-6377 Sponge Caddy
K-6378 Kitchen Brush Caddy
K-6379 Kitchen Squeegee
K-6382 Disinfecting Wipes Dispenser
K-6383 Soap Dispenser
K-8618 Paper Towel Holder
K-8619 Flexible Kitchen Mat
K-8624 Dish Scraper
K-8801 Sink Strainer
K-8799 Sink Strainer



Codes/Standards















ASME A112.19.1/CSA B45.2

KOHLER® Enameled Cast Iron Kitchen Sink Lifetime Limited Warranty

See website for detailed warranty information.

Available Colors/Finishes

Color tiles intended for reference only.

| Color | Code | Description |
|--|------|---------------|
|  | 0 | White |
|  | FF | Sea Salt™ |
|  | 96 | Biscuit |
|  | 47 | Almond |
|  | FD | Cane Sugar™ |
|  | NY | Dune |
|  | 95 | Ice™ Grey |
|  | G9 | Sandbar |
|  | 33 | Mexican Sand™ |
|  | K4 | Cashmere |
|  | FT | Basalt |
|  | 58 | Thunder™ Grey |
|  | KA | Black 'n Tan |
|  | FP | Caviar |
|  | 7 | Black Black™ |

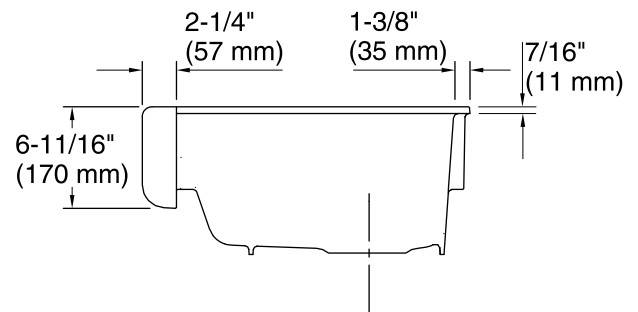
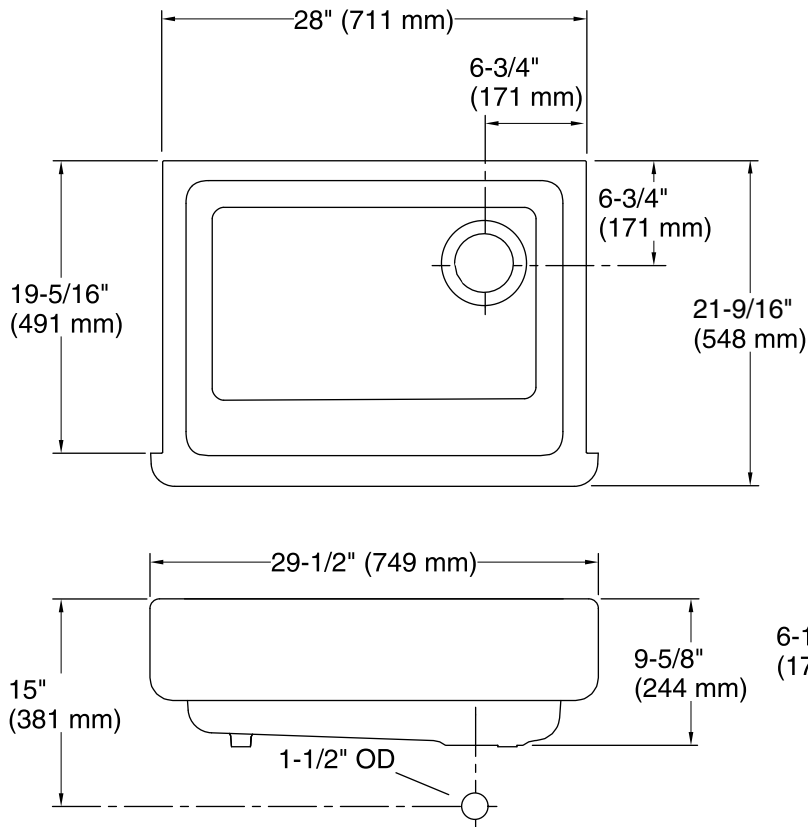

Technical Information

All product dimensions are nominal.

| | |
|--------------------------|---|
| Bowl configuration: | Single |
| Installation: | Under-mount |
| Min. base cabinet width: | 30" (762 mm) |
| Bowl area (Only): | Length: 24-3/4" (629 mm) Width: 18-1/16" (459 mm) Bowl depth: 9" (229 mm) |
| Drain hole: | 3-5/8" (92 mm) |
| Template: | 1156909-7, required, included 1211543-7, required, included |

Notes

Install this product according to the installation instructions.

NOTICE: Countertop manufacturer or cutter must use the current product template available at www.kohler.com, or by calling 1-800-4KOHLER. Kohler Co. is not responsible for cutout errors when the incorrect cutout template is used.

IMPORTANT! The distance from the top edge of the cabinet to the top of the cabinet door must be at least 6-7/8" (175 mm) to install this sink.