

### Features

- One-piece toilets integrate the tank and bowl into a seamless, easy-to-clean design.
- Round-front bowl offers an ideal solution for smaller baths and powder rooms.
- Low-profile design.
- 1.28 gallons per flush (gpf).
- Standard left-hand trip lever included.
- Includes K-4009 Reveal® Quiet-Close™ with Grip-Tight seat.

### Technology

- Single-flush gravity uses the force of gravity and a precision-engineered tank, bowl, and trapway to create a strong siphon during flushing.
- AquaPiston canister allows water to flow into the bowl from all sides (360 degrees), increasing the power and effectiveness of the flush.
- Flush valve's 3:2 ratio harnesses the natural force of gravity and optimizes flush performance.
- Durable canister design has 90% less exposed seal material than a 3-inch flapper, for leak-free performance.
- Light-touch canister flush requires a lower actuation force than a flapper.

### Installation

- Standard 12-inch rough-in.
- Supply line not included.

### Water Conservation & Rebates

- WaterSense® toilets meet strict EPA flushing guidelines, including using at least 20 percent less water than 1.6-gallon toilets.
- Eligible for consumer rebates in some municipalities.

### Recommended Products/Accessories

K-75758 Cachet® Nightlight Quiet-Close™ Round-Front Toilet Seat  
 K-76923 Puretide™ Quiet-Close™ Round-Front Manual Cleansing Toilet Seat  
 K-5420 Low-Profile Bolt Caps  
 K-9176 Trip Lever  
 1023457 Wax Ring/Hardware Kit  
 1265114 Connector Hose

### Included Components

Additional Components:  
 Bolt cap accessory pack  
 Tank Accessory Pack  
 Tank Cover  
 Trip Lever



### Codes/Standards











ASME A112.19.2/CSA B45.1  
 DOE - Energy Policy Act 1992  
 EPA WaterSense®

### KOHLER® One-Year Limited Warranty

See website for detailed warranty information.

### Available Colors/Finishes

*Color tiles intended for reference only.*

| Color  | Code | Description   |
|--|------|---------------|
|  | 0    | White         |
|  | 96   | Biscuit       |
|  | 47   | Almond        |
|  | NY   | Dune          |
|  | 95   | Ice™ Grey     |
|  | G9   | Sandbar       |
|  | 33   | Mexican Sand™ |
|  | K4   | Cashmere      |
|  | 58   | Thunder™ Grey |
|  | 7    | Black Black™  |

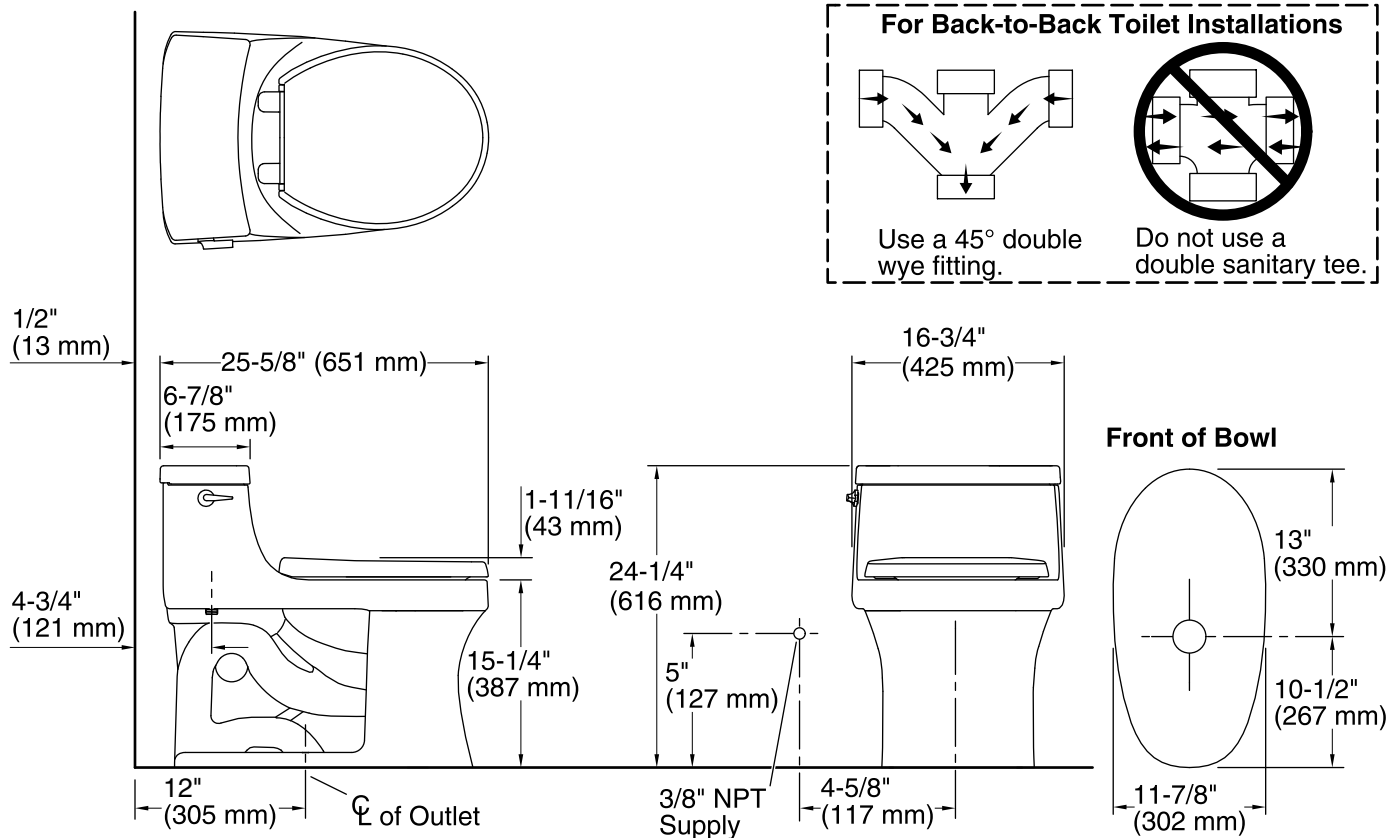

### Technical Information

All product dimensions are nominal.

Toilet type: One-piece, Floor-mount

Waste Outlet: Floor

Bowl shape: Round-front

Flush type: AquaPiston®

Trap passageway: 2-1/8" (54 mm)

Water Consumption

Full: 1.28 gpf (4.8 lpf)

Water surface size: 9-1/4" x 6-3/4" (235 mm x 171 mm)

Rim to water surface: 6-5/16" (160 mm)

Rough-in: 12" (305 mm)

Seat-mounting holes: 5-1/2" (140 mm)

### Fixture Supply Requirements

Min static pressure: 20 psi (137.9 kPa)

Max static pressure: 80 psi (551.6 kPa)

### Notes

Install this product according to the installation instructions.

For back-to-back toilet installations: Use only a 45° double wye fitting.