



Features

- Bask® heated surface creates spa-like relaxation with soothing warmth on your back and neck.
- Three heat settings allow you to customize the surface temperature.
- Single-speed whirlpool offers performance and value, with 5 fully adjustable jets.
- Hydromassage flow and direction can be controlled at each jet.
- Hourglass shape adds style and elegance to your bathroom.
- Textured bottom surface
- Reversible drain.

Material

- Acrylic

Hydrotherapy

- Whirlpool

Installation

- Drop-in

Additional Hydrotherapy Options

- Soaking Bath - 1242-0
- Soaking Bath + Bask heated surface - 1242-W1
- BubbleMassage air bath - 1239-G
- VibrAcoustic - 1239-VB
- VibrAcoustic + Bask heated surface - 1239-VBW
- Whirlpool - 1239-0
- Whirlpool + heater - 1239-H
- Whirlpool + Bask heated surface - 1239-W1

Recommended Products/Accessories

- K-1278 Removable Apron
- K-7161-AF Bath Drain
- K-9695 5-Jet Trim Kit
- K-24916 Wireless Music Kit
- K-37380 30" Rough-in Cable Bath Drain
- K-37383 30" Rough-in Cable Bath Drain
- K-37386 rough-in cable drain, PVC, 30" cable



Codes/Standards

ASME A112.19.7/CSA B45.10
CSA B45.5/IAPMO Z124
ASTM E162
ASTM E662
UL 1795
Greenguard UL 2818 - Gold





**KOHLER® Plastic Baths and Receptors
Lifetime Limited Warranty
KOHLER® Hydrotherapy Components
Five-Year Limited Warranty**

See website for detailed warranty information.

Available Colors/Finishes

Color tiles intended for reference only.

Color Code Description

Color	Code	Description
	0	White
	96	Biscuit
	47	Almond
	NY	Dune
	G9	Sandbar

No change in measurements if connected with drain illustrated. (K-7161-AF)

□ Recommended Faucet Location

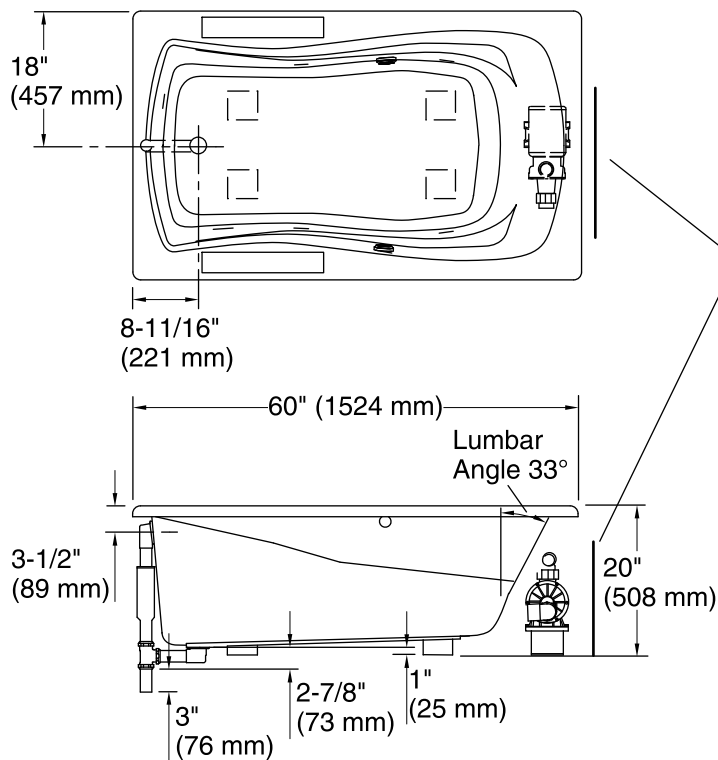

Pump/Control Access
(If Apron Is Not Used)
30" (762 mm) W x
15" (381 mm) H Min

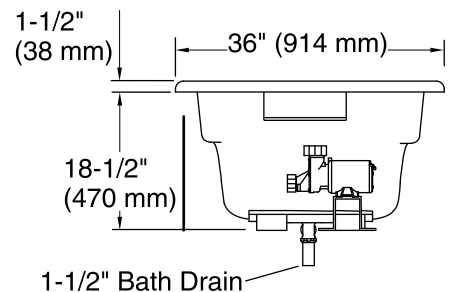
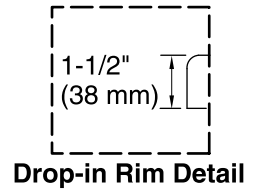

Required Electrical Service

One dedicated circuit required, protected with Class A Ground-Fault Circuit-Interrupter (GFCI). Outside North America, this device may be known as a Residual Current Device (RCD).

Pump, Heated 120 V, 15 A, 60 Hz
Surface:

Technical Information

All product dimensions are nominal.

Installation:	Drop-in
Drain location:	End
Basin area, bottom:	46" x 24" (1168 mm x 610 mm)
Basin area, top:	54" x 27" (1372 mm x 686 mm)
Weight:	111 lbs (50.3 kg)
Minimum floor load:	44 lbs/ft ² (214.8 kg/m ²)
Water depth:	14" (356 mm)
Water capacity:	63 gal (238.5 L)
Cutout:	Drop-in, 58" x 34" (1473 mm x 864 mm)
Electrical component rating:	Pump: 120 V, 7 A, 60 Hz Heated Surface: 120 V, 0.5 A, 60 Hz, 65 W
Pump speed:	Single

Notes

Measure your actual product for rough-in details. Install this product according to the installation instructions.

The hot water supply should be 70% of the capacity of the bath or greater. Installations will vary.

If installing a rim-mount faucet, make sure there is no interference with drain overflow before drilling any holes. Consult local and national codes for minimum air gap requirements if installing a spout on the faucet deck.