

Features

- Acrylic
- One-piece configuration
- For alcove installations
- Removable cover
- Drain hole at center
- 48" (1219 mm) x 48" (1219 mm) x 3-15/16" (100 mm)

ACRYLIC SHOWER RECEPTOR WITH REMOVABLE COVER K-9394

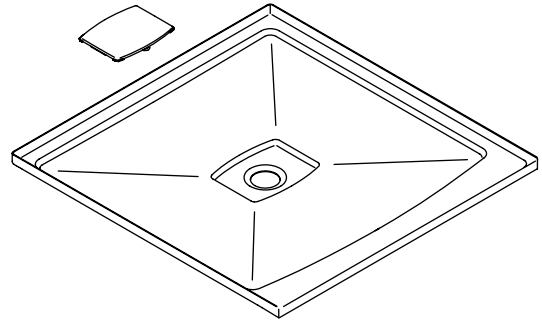

Codes/Standards Applicable

Specified model meets or exceeds the following:

- ANSI Z124.1.2
- CSA B45.0
- CSA B45.5
- ASTM E162
- ASTM E662

Colors/Finishes

- 0: White
- Other: Refer to Price Book for additional colors/finishes

Accessories

- CP: Polished Chrome
- PB: Vibrant® Polished Brass
- Other: Refer to Price Book for additional colors/finishes

Specified Model

Model	Description	Colors/Finishes		
K-9394	Acrylic shower receptor with removable cover	<input type="checkbox"/> 0	<input type="checkbox"/> Other_____	
Recommended Accessories				
K-9132	Shower drain	<input type="checkbox"/> CP	<input type="checkbox"/> PB	<input type="checkbox"/> Other_____
Optional Accessories				
Refer to the Fixtures Price Book for shower door selections, glass options, and color information.				

Product Specification

The acrylic shower receptor with removable cover shall be 48" (1219 mm) in length, 48" (1219 mm) in width, and 3-15/16" (100 mm) in height. Shower receptor shall be for alcove installations. Shower receptor shall be one-piece configuration with drain hole at center. Shower receptor shall be Kohler Model K-9394-_____.

ARCHER®

Technical Information

Fixture*:	
Weight	54 lbs (24.5 kg)
Configuration	one-piece
Drain hole	Ø 3-3/8" (86 mm)
* Approximate measurements for comparison only.	
Included components:	
Removable cover	1062356

Installation Notes

Install this product according to the installation guide.

Shimming may be required to level the fixture.

Shimming may be required between the stud frame and the fixture.

The stud opening tolerance is +1/4" (6 mm), -0" (0 mm).

When fire rated construction is specified, dimensions are to the inside of the fire-rated wall.

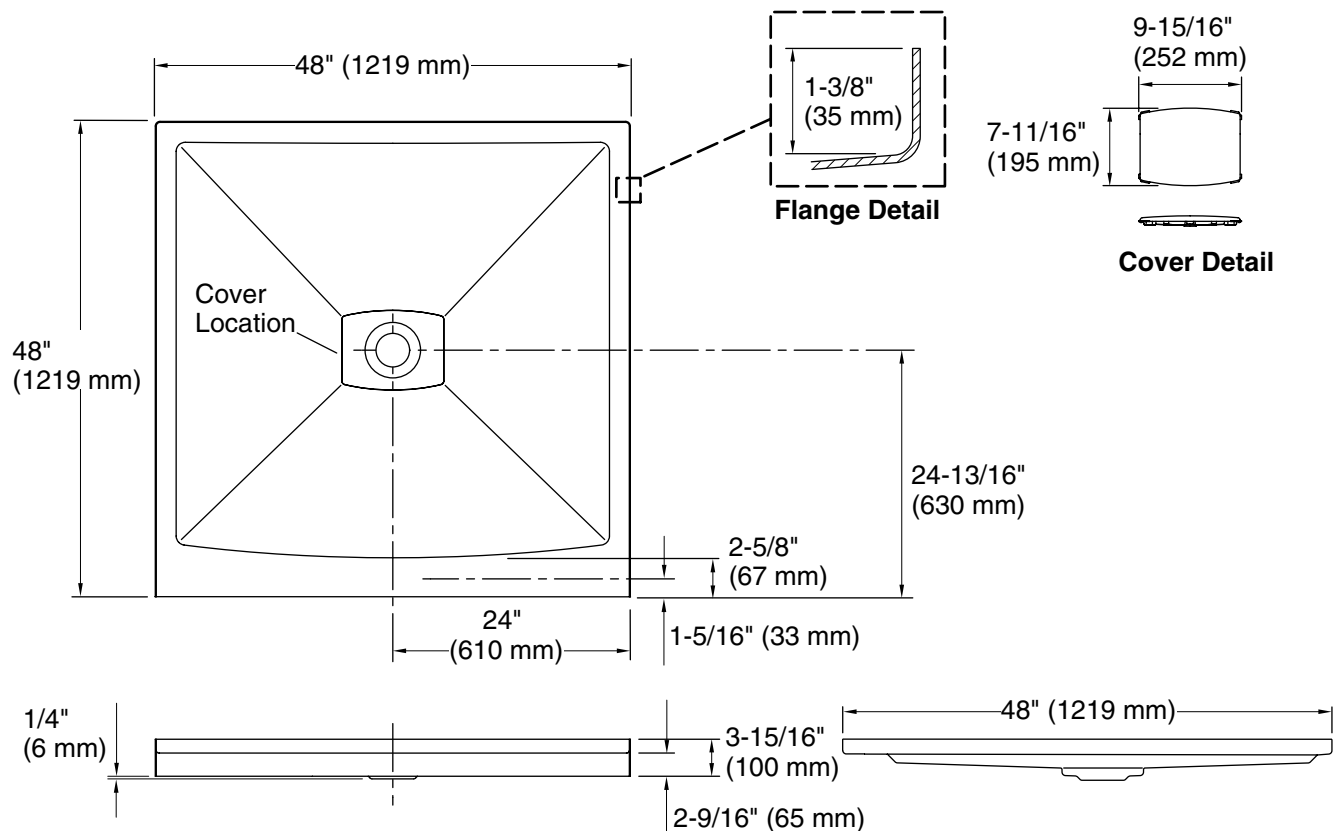

Product Diagram

ARCHER® ACRYLIC SHOWER RECEPTOR WITH REMOVABLE COVER

Page 2 of 2
1066258-4-E

THE BOLD LOOK
OF **KOHLER**®